

KOD/CODE
NRS- 101

ANKASTRE EVYE INSET SINK

ÖZELLİKLER / SPECIFICATION

Genel Ölçüler	Over All Dimensions	480x730 mm
Küvet Ölçüleri	Bowl Dimensions	360x400 mm
Kalınlık	Thickness	0.60 - 0.80 mm
Yüzey	Surface	Satin / Linen
Malzeme	Material	304 Paslanmaz Çelik / Stainless Steel
Sifon	Siphon	Büyük Sifon / Big Siphon Ø 90 mm (B) Küçük Sifon / Small Siphon Ø 55 mm (S)
Damlalık Yönü	Dropper Direction	Sağ Damlalık / Right Dropper (R) Sol Damlalık / Left Dropper (L)
Taşma	Overflow	Taşma Açılacak / Overflow (W) Taşmasız Without / Overflow (X)
Musluk Deliği	Faucet Hole	Musluk Deliği Açılacak / Faucet Hole (F) Musluksuz / No Faucet Hole (X)
Düz Kenar	Flat Side	0.80 mm' de Düz Kenar Üretilir Flat Side are Manufactured at 0.80 mm



NRS 101S / Satin NRS 101L / Linen Inset

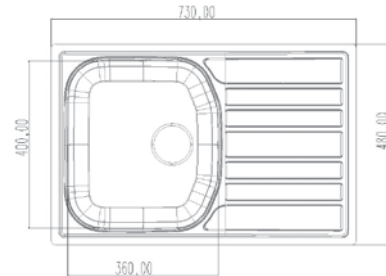

NORMO

ANKASTRE EVYE INSET SINK

ÖZELLİKLER / SPECIFICATION

Genel Ölçüler	Over All Dimensions	480x620 mm
Küvet Ölçüleri	Bowl Dimensions	360x400 mm
Kalınlık	Thickness	0.60 - 0.80 mm
Yüzey	Surface	Satin / Linen
Malzeme	Material	304 Paslanmaz Çelik / Stainless Steel
Sifon	Siphon	Büyük Sifon / Big Siphon Ø 90 mm (B) Küçük Sifon / Small Siphon Ø 55 mm (S)
Damlalık Yönü	Dropper Direction	Sağ Damlalık / Right Dropper (R) Sol Damlalık / Left Dropper (L)
Taşma	Overflow	Taşma Açılacak / Overflow (W) Taşmasız / Without Overflow (X)
Musluk Deliği	Faucet Hole	Musluk Deliği Açılacak / Faucet Hole (F) Musluksuz / No Faucet Hole (X)
Düz Kenar	Flat Side	0.80 mm' de Düz Kenar Üretilbilir Flat Side are Manufactured at 0.80 mm

NRS 103S / Satin NRS 103L / Linen Inset

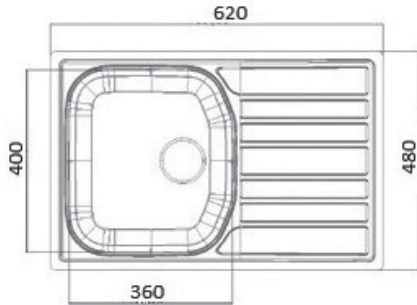

KOD/CODE
NRS- 105

ANKASTRE EVYE INSET SINK

ÖZELLİKLER / SPECIFICATION

Genel Ölçüler	Over All Dimensions	480x480 mm
Küvet Ölçüleri	Bowl Dimensions	360x400 mm
Kalınlık	Thickness	0.60 - 0.80 mm
Yüzey	Surface	Satin / Linen
Malzeme	Material	304 Paslanmaz Çelik / Stainless Steel
Sifon	Siphon	Büyük Sifon / Big Siphon Ø 90 mm (B) Küçük Sifon / Small Siphon Ø 55 mm (S)
Damlalık Yönü	Dropper Direction	Sağ Damlalık / Right Dropper (R) Sol Damlalık / Left Dropper (L)
Taşma	Overflow	Taşma Açılacak / Overflow (W) Taşmasız / Without Overflow (X)
Musluk Deliği	Faucet Hole	Musluk Deliği Açılacak / Faucet Hole (F) Musluksuz / No Faucet Hole (X)
Düz Kenar	Flat Side	0.80 mm' de Düz Kenar Üretilbilir Flat Side are Manufactured at 0.80 mm



NRS 105S / Satin NRS 105L / Linen Inset

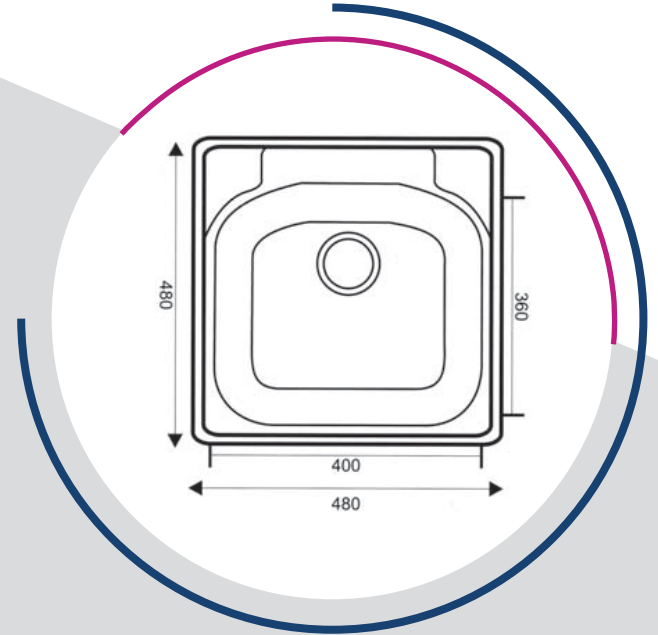

NORMO

ANKASTRE EVYE
INSET SINK

ÖZELLİKLER / SPECIFICATION

Genel Ölçüler	Over All Dimensions	Ø 480 mm
Küvet Ölçüleri	Bowl Dimensions	370x380 mm
Kalınlık	Thickness	0.60 - 0.80 mm
Yüzey	Surface	Satin / Linen
Malzeme	Material	304 Paslanmaz Çelik / Stainless Steel
Sifon	Siphon	Büyük Sifon / Big Siphon Ø 90 mm (B) Küçük Sifon / Small Siphon Ø 55 mm (S)
Damlalık Yönü	Dropper Direction	Sağ Damlalıklı / Right Dropper (R) Sol Damlalıklı / Left Dropper (L)
Taşma	Overflow	Taşma Açılacak / Overflow (W) Taşmasız / Without Overflow (X)
Musluk Deliği	Faucet Hole	Musluk Deliği Açılacak / Faucet Hole (F) Musluksuz / No Faucet Hole (X)
Düz Kenar	Flat Side	0.80 mm' de Düz Kenar Üretilbilir Flat Side are Manufactured at 0.80 mm

NRS 107S / Satin NRS 107L / Linen Inset

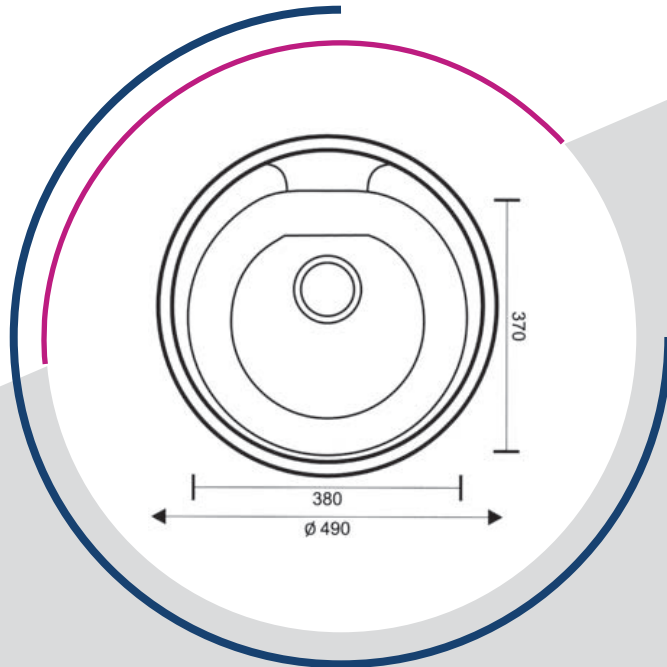
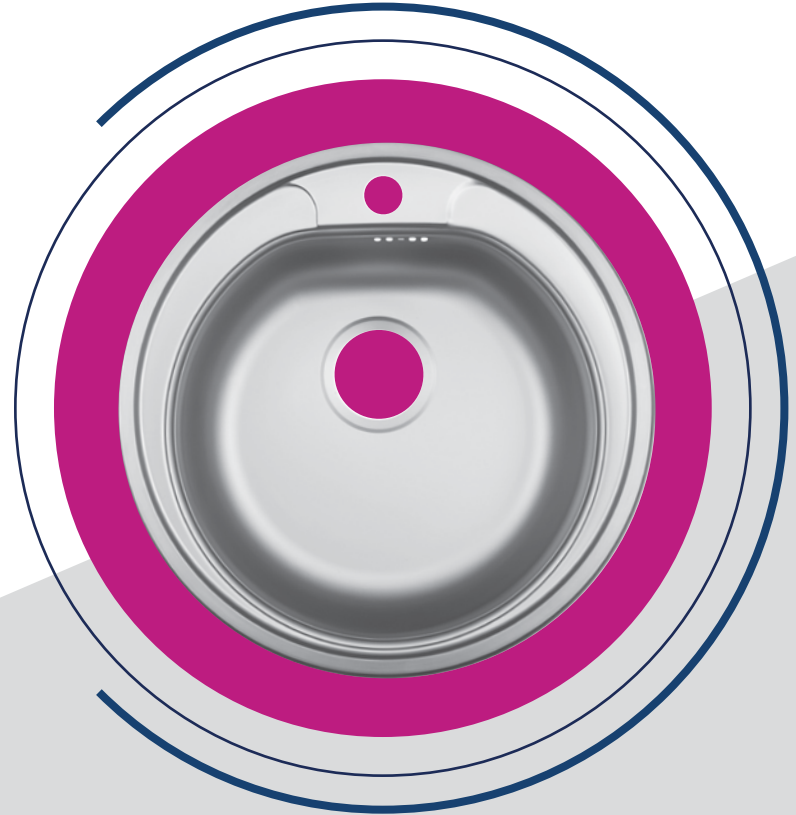

KOD/CODE
NRS- 109

ANKASTRE EVYE INSET SINK

ÖZELLİKLER / SPECIFICATION

Genel Ölçüler	Over All Dimensions	480x780 mm
Küvet Ölçüleri	Bowl Dimensions	370x380 mm
Kalınlık	Thickness	0.60 - 0.80 mm
Yüzey	Surface	Satin / Linen
Malzeme	Material	304 Paslanmaz Çelik / Stainless Steel
Sifon	Siphon	Büyük Sifon / Big Siphon Ø 90 mm (B) Küçük Sifon / Small Siphon Ø 55 mm (S)
Damlalık Yönü	Dropper Direction	Sağ Damlalıklı / Right Dropper (R) Sol Damlalıklı / Left Dropper (L)
Taşma	Overflow	Taşma Açılacak / Overflow (W) Taşmasız / Without Overflow (X)
Musluk Deliği	Faucet Hole	Musluk Deliği Açılacak / Faucet Hole (F) Musluksuz / No Faucet Hole (X)
Düz Kenar	Flat Side	0.80 mm' de Düz Kenar Üretilebilir Flat Side are Manufactured at 0.80 mm

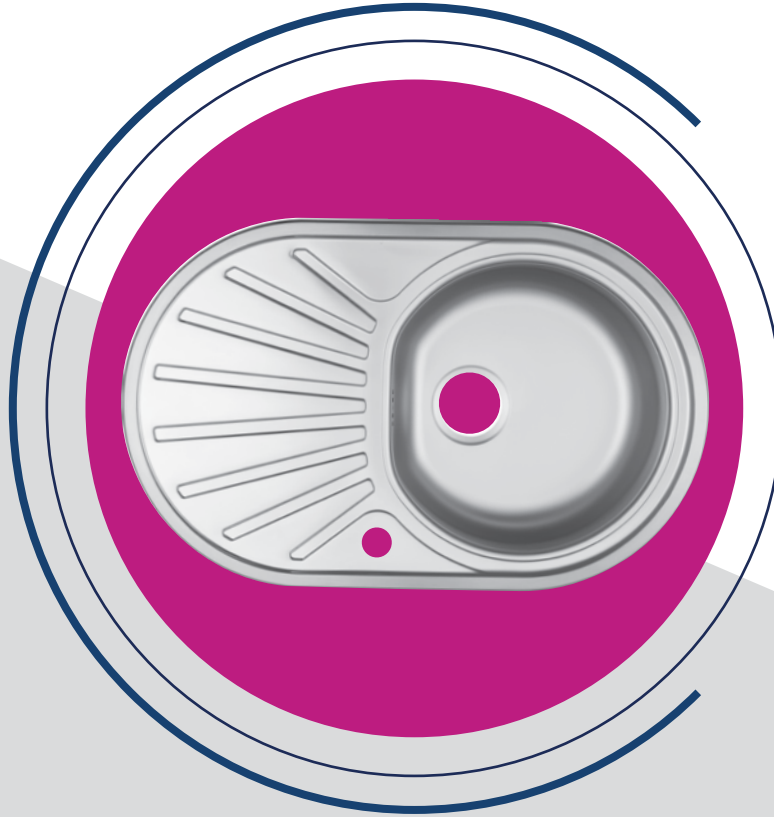

NRS 109S / Satin

NRS 109L / Linen

Inset

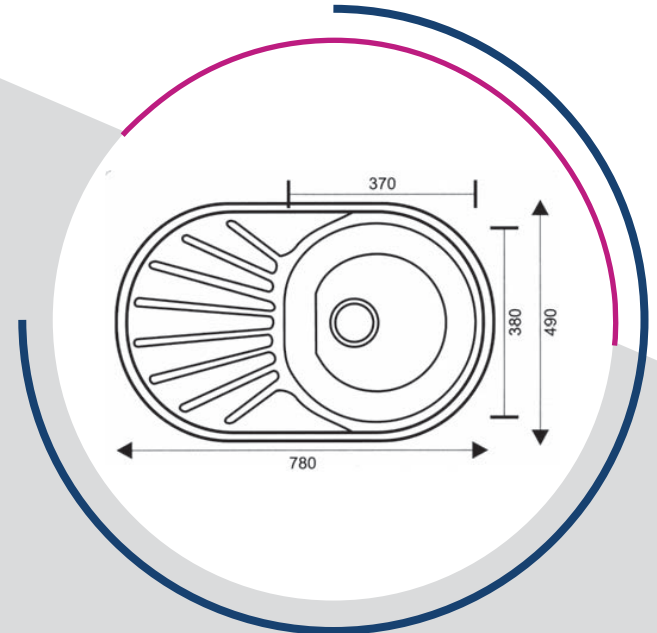
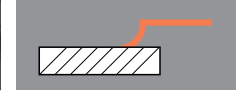

ANKASTRE EVYE INSET SINK

ÖZELLİKLER / SPECIFICATION

Genel Ölçüler	Over All Dimensions	480x780 mm
Küvet Ölçüleri	Bowl Dimensions	370x380 mm
Kalınlık	Thickness	0.60 - 0.80 mm
Yüzey	Surface	Satin / Linen
Malzeme	Material	304 Paslanmaz Çelik / Stainless Steel
Sifon	Siphon	Büyük Sifon / Big Siphon Ø 90 mm (B) Küçük Sifon / Small Siphon Ø 55 mm (S)
Damlalık Yönü	Dropper Direction	Sağ Damlalıklı / Right Dropper (R) Sol Damlalıklı / Left Dropper (L)
Taşma	Overflow	Taşma Açılacak / Overflow (W) Taşmasız / Without Overflow (X)
Musluk Deliği	Faucet Hole	Musluk Deliği Açılacak / Faucet Hole (F) Musluksuz / No Faucet Hole (X)
Düz Kenar	Flat Side	0.80 mm' de Düz Kenar Üretilabilir Flat Side are Manufactured at 0.80 mm

NRS 111S / Satin NRS 111L / Linen Inset

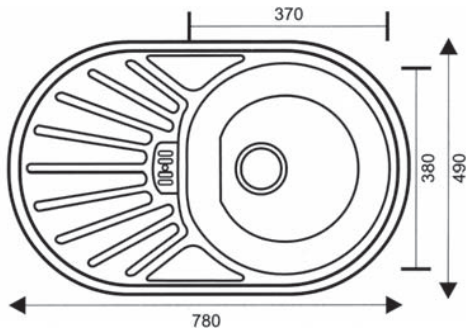
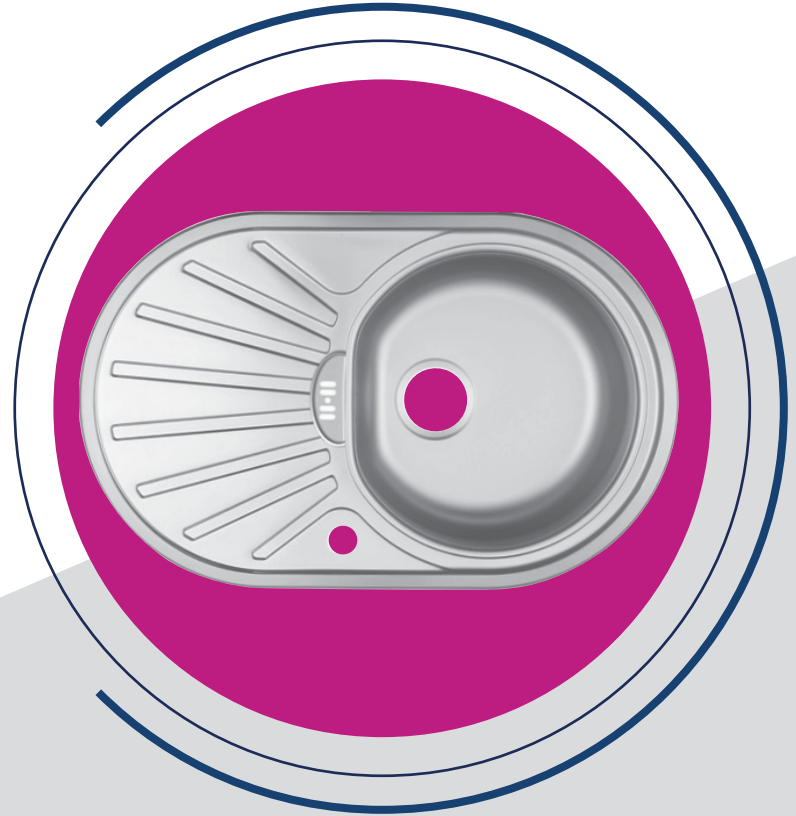

KOD/CODE
NRS- 113

ANKASTRE EVYE INSET SINK

ÖZELLİKLER / SPECIFICATION

Genel Ölçüler	Over All Dimensions	480x600 mm
Küvet Ölçüleri	Bowl Dimensions	370x380 mm
Kalınlık	Thickness	0.60 - 0.80 mm
Yüzey	Surface	Satin / Linen
Malzeme	Material	304 Paslanmaz Çelik / Stainless Steel
Sifon	Siphon	Büyük Sifon / Big Siphon Ø 90 mm (B) Küçük Sifon / Small Siphon Ø 55 mm (S)
Damlalık Yönü	Dropper Direction	Sağ Damlalık / Right Dropper (R) Sol Damlalık / Left Dropper (L)
Taşma	Overflow	Taşma Açılacak / Overflow (W) Taşmasız / Without Overflow (X)
Musluk Deliği	Faucet Hole	Musluk Deliği Açılacak / Faucet Hole (F) Musluksuz / No Faucet Hole (X)
Düz Kenar	Flat Side	0.80 mm' de Düz Kenar Üretilbilir Flat Side are Manufactured at 0.80 mm

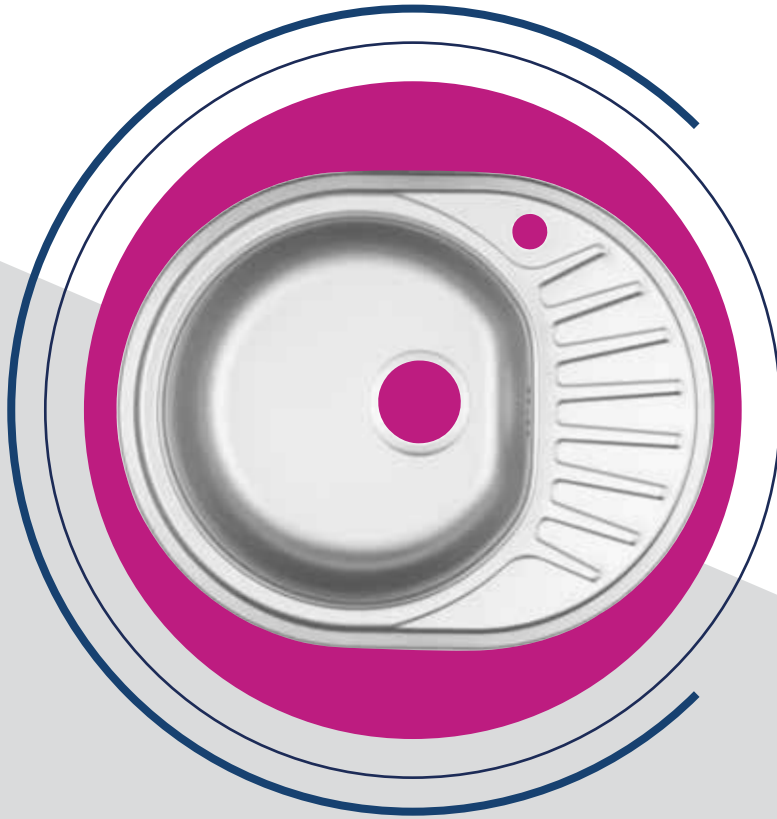

NRS 113S / Satin NRS 113L / Linen Inset

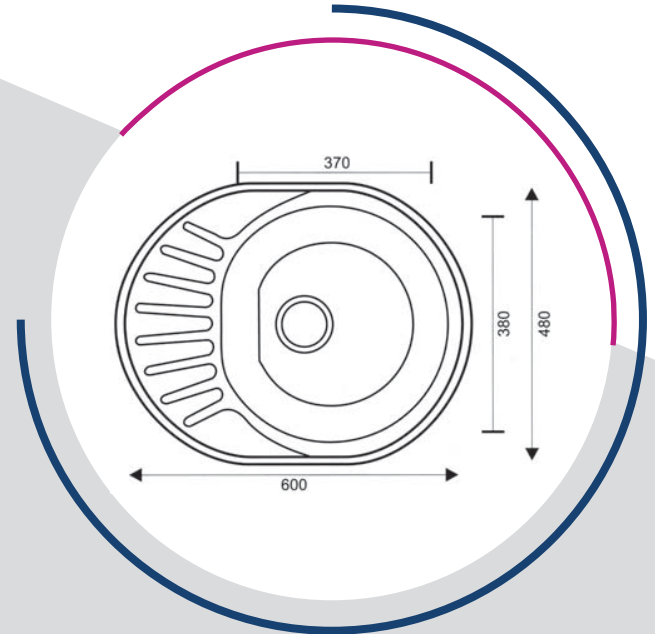

NORMO

ANKASTRE EVYE INSET SINK

ÖZELLİKLER / SPECIFICATION

Genel Ölçüler	Over All Dimensions	480x780 mm
Küvet Ölçüleri	Bowl Dimensions	360x400 mm
Kalınlık	Thickness	0.60 - 0.80 mm
Yüzey	Surface	Satin / Linen
Malzeme	Material	304 Paslanmaz Çelik / Stainless Steel
Sifon	Siphon	Büyük Sifon / Big Siphon Ø 90 mm (B) Küçük Sifon / Small Siphon Ø 55 mm (S)
Damlalık Yönü	Dropper Direction	Sağ Damlalıklı / Right Dropper (R) Sol Damlalıklı / Left Dropper (L)
Taşma	Overflow	Taşma Açılacak / Overflow (W) Taşmasız / Without Overflow (X)
Musluk Deliği	Faucet Hole	Musluk Deliği Açılacak / Faucet Hole (F) Musluksuz / No Faucet Hole (X)
Düz Kenar	Flat Side	0.80 mm' de Düz Kenar Üretilbilir Flat Side are Manufactured at 0.80 mm

NRS 115S / Satin NRS 115L / Linen Inset

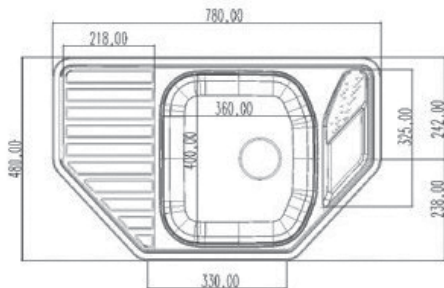

KOD/CODE
NRS- 117

ANKASTRE EVYE INSET SINK

ÖZELLİKLER / SPECIFICATION

Genel Ölçüler	Over All Dimensions	500x1000 mm
Küvet Ölçüleri	Bowl Dimensions	360x400 mm
Kalınlık	Thickness	0.60 - 0.80 mm
Yüzey	Surface	Satin / Linen
Malzeme	Material	304 Paslanmaz Çelik / Stainless Steel
Sifon	Siphon	Büyük Sifon / Big Siphon Ø 90 mm (B) Küçük Sifon / Small Siphon Ø 55 mm (S)
Damlalık Yönü	Dropper Direction	Sağ Damlalık / Right Dropper (R) Sol Damlalık / Left Dropper (L)
Taşma	Overflow	Taşma Açılacak / Overflow (W) Taşmasız / Without Overflow (X)
Musluk Deliği	Faucet Hole	Musluk Deliği Açılacak / Faucet Hole (F) Musluksuz / No Faucet Hole (X)
Düz Kenar	Flat Side	0.80 mm' de Düz Kenar Üretilir Flat Side are Manufactured at 0.80 mm

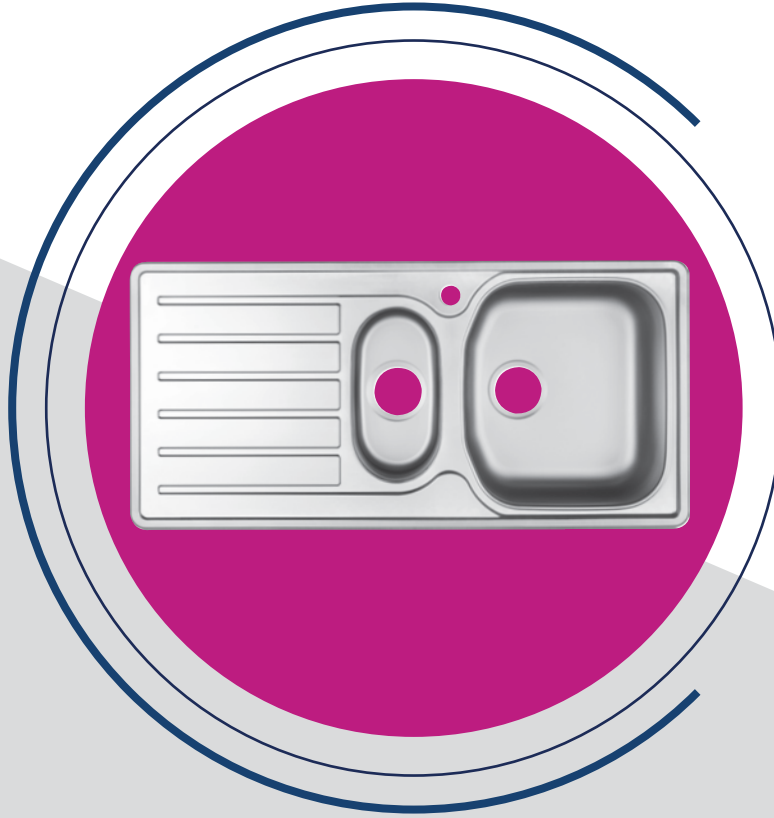

NRS 117S / Satin NRS 117L / Linen Inset

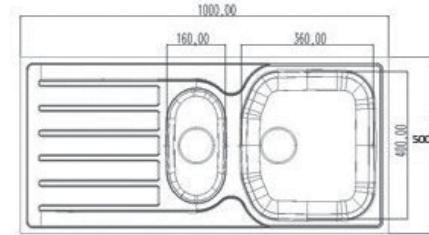

NORMO

ANKASTRE EVYE INSET SINK

ÖZELLİKLER / SPECIFICATION

Genel Ölçüler	Over All Dimensions	435x760 mm
Küvet Ölçüleri	Bowl Dimensions	345x365 mm
Kalınlık	Thickness	0.50 - 0.60 mm (Satin) 0.60 mm (Linen)
Yüzey	Surface	Satin / Linen
Malzeme	Material	304 Paslanmaz Çelik / Stainless Steel
Sifon	Siphon	Büyük Sifon / Big Siphon Ø 90 mm (B) Küçük Sifon / Small Siphon Ø 55 mm (S)
Damlalık Yönü	Dropper Direction	Sağ Damlalıklı / Right Dropper (R) Sol Damlalıklı / Left Dropper (L)
Taşma	Overflow	Taşma Açılacak / Overflow (W) Taşmasız / Without Overflow (X)
Musluk Deliği	Faucet Hole	Musluk Deliği Açılacak / Faucet Hole (F) Musluksuz / No Faucet Hole (X)
Düz Kenar	Flat Side	0.80 mm' de Düz Kenar Üretilbilir Flat Side are Manufactured at 0.80 mm

NRS 119S / Satin NRS 119L / Linen Inset

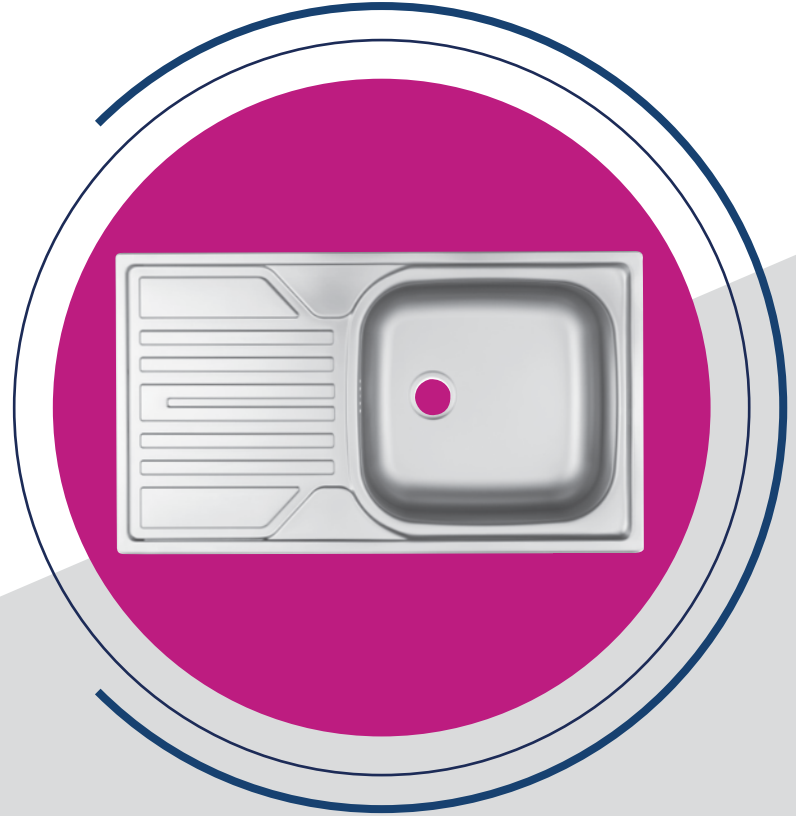
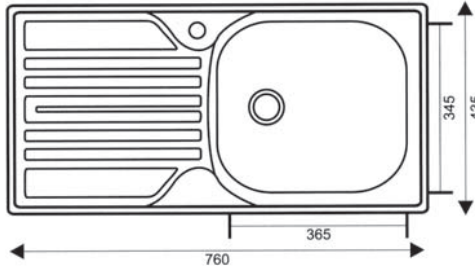

KOD/CODE
NRS- 120

ANKASTRE EVYE INSET SINK

ÖZELLİKLER / SPECIFICATION

Genel Ölçüler	Over All Dimensions	435x760 mm
Küvet Ölçüleri	Bowl Dimensions	345x365 mm
Kalınlık	Thickness	0.50 - 0.60 mm (Satin) 0.60 mm (Linen)
Yüzey	Surface	Satin / Linen
Malzeme	Material	304 Paslanmaz Çelik / Stainless Steel
Sifon	Siphon	Büyük Sifon / Big Siphon Ø 90 mm (B) Küçük Sifon / Small Siphon Ø 55 mm (S)
Damlalık Yönü	Dropper Direction	Sağ Damlalık / Right Dropper (R) Sol Damlalık / Left Dropper (L)
Taşma	Overflow	Taşma Açılacak / Overflow (W) Taşmasız / Without Overflow (X)
Musluk Deliği	Faucet Hole	Musluk Deliği Açılacak / Faucet Hole (F) Musluksuz / No Faucet Hole (X)
Düz Kenar	Flat Side	0.80 mm' de Düz Kenar Üretilbilir Flat Side are Manufactured at 0.80 mm

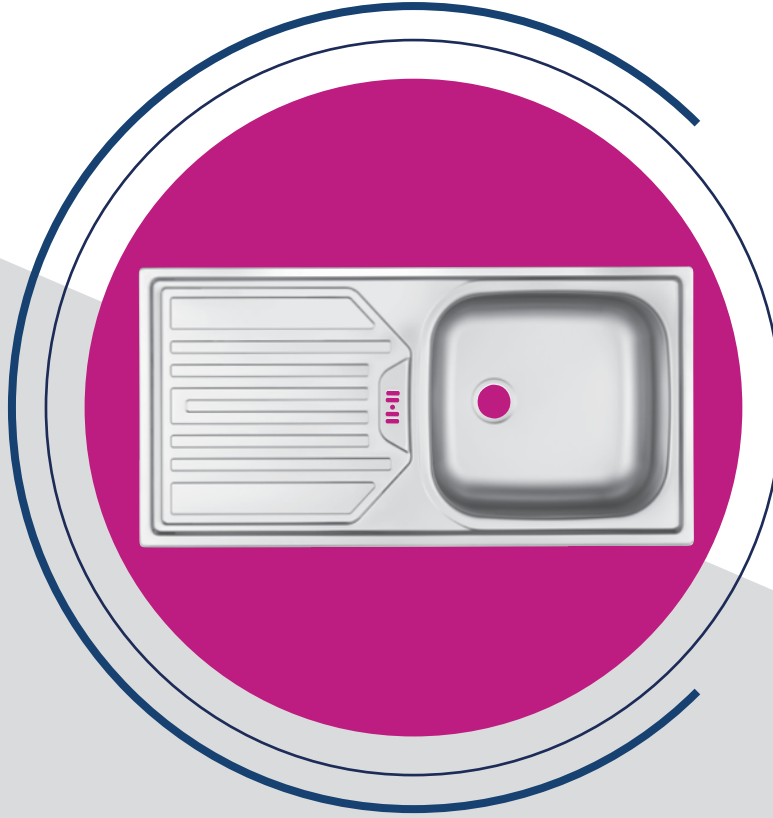

NRS 120S / Satin NRS 120L / Linen Inset

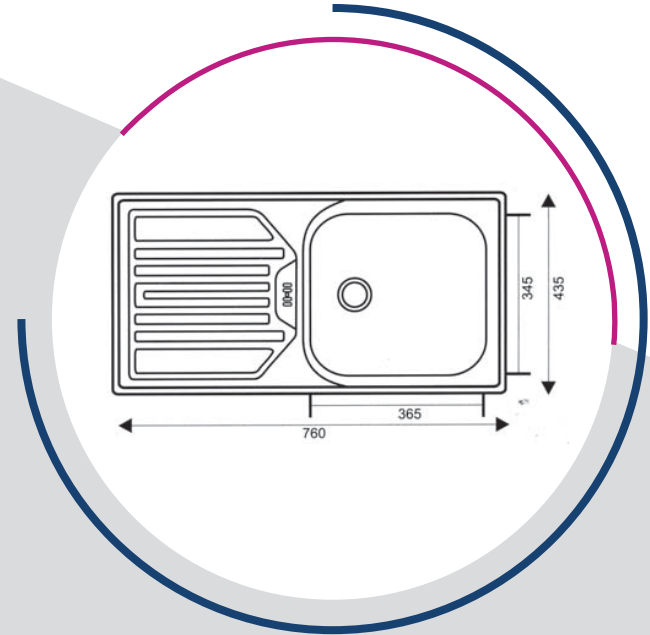

NORMO

ANKASTRE EVYE INSET SINK

ÖZELLİKLER / SPECIFICATION

Genel Ölçüler	Over All Dimensions	435x860 mm
Küvet Ölçüleri	Bowl Dimensions	345x365 mm
Kalınlık	Thickness	0.50 - 0.60 mm (Satin) 0.60 mm (Linen)
Yüzey	Surface	Satin / Linen
Malzeme	Material	304 Paslanmaz Çelik / Stainless Steel
Sifon	Siphon	Büyük Sifon / Big Siphon Ø 90 mm (B) Küçük Sifon / Small Siphon Ø 55 mm (S)
Damlalık Yönü	Dropper Direction	Sağ Damlalıklı / Right Dropper (R) Sol Damlalıklı / Left Dropper (L)
Taşma	Overflow	Taşma Açılacak / Overflow (W) Taşmasız / Without Overflow (X)
Musluk Deliği	Faucet Hole	Musluk Deliği Açılacak / Faucet Hole (F) Musluksuz / No Faucet Hole (X)
Düz Kenar	Flat Side	0.80 mm' de Düz Kenar Üretilabilir Flat Side are Manufactured at 0.80 mm

NRS 122S / Satin NRS 122L / Linen Inset

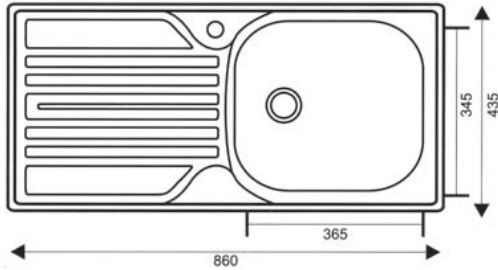
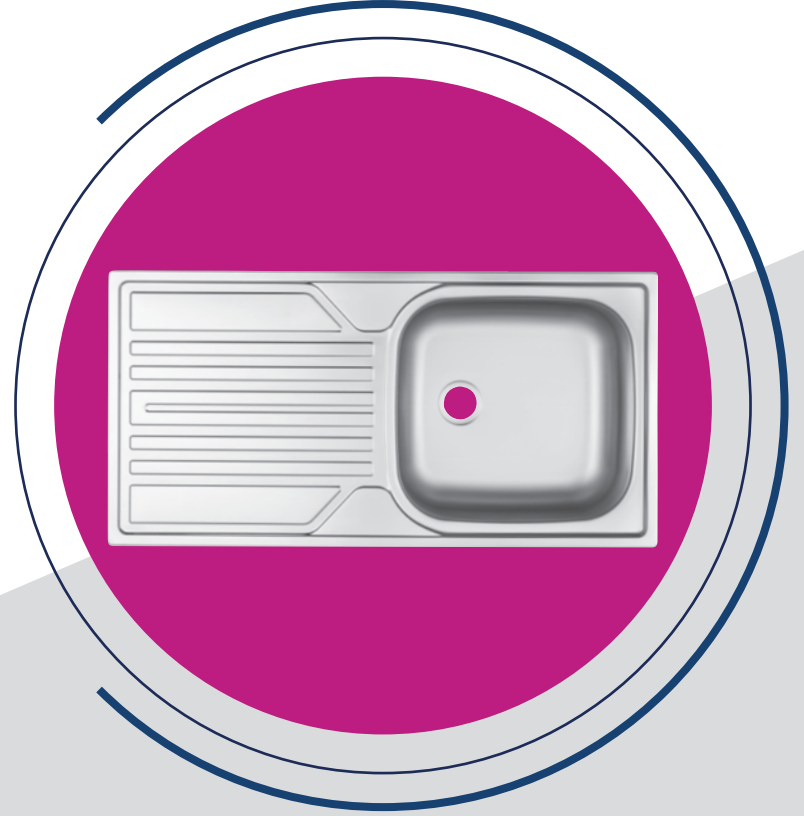

KOD/CODE
NRS- 123

ANKASTRE EVYE INSET SINK

ÖZELLİKLER / SPECIFICATION

Genel Ölçüler	Over All Dimensions	435x860 mm
Küvet Ölçüleri	Bowl Dimensions	345x365 mm
Kalınlık	Thickness	0.50 - 0.60 mm (Satin) 0.60 mm (Linen)
Yüzey	Surface	Satin / Linen
Malzeme	Material	304 Paslanmaz Çelik / Stainless Steel
Sifon	Siphon	Büyük Sifon / Big Siphon Ø 90 mm (B) Küçük Sifon / Small Siphon Ø 55 mm (S)
Damlalık Yönü	Dropper Direction	Sağ Damlalıklı / Right Dropper (R) Sol Damlalıklı / Left Dropper (L)
Taşma	Overflow	Taşma Açılacak / Overflow (W) Taşmasız / Without Overflow (X)
Musluk Deliği	Faucet Hole	Musluk Deliği Açılacak / Faucet Hole (F) Musluksuz / No Faucet Hole (X)
Düz Kenar	Flat Side	0.80 mm' de Düz Kenar Üretilbilir Flat Side are Manufactured at 0.80 mm

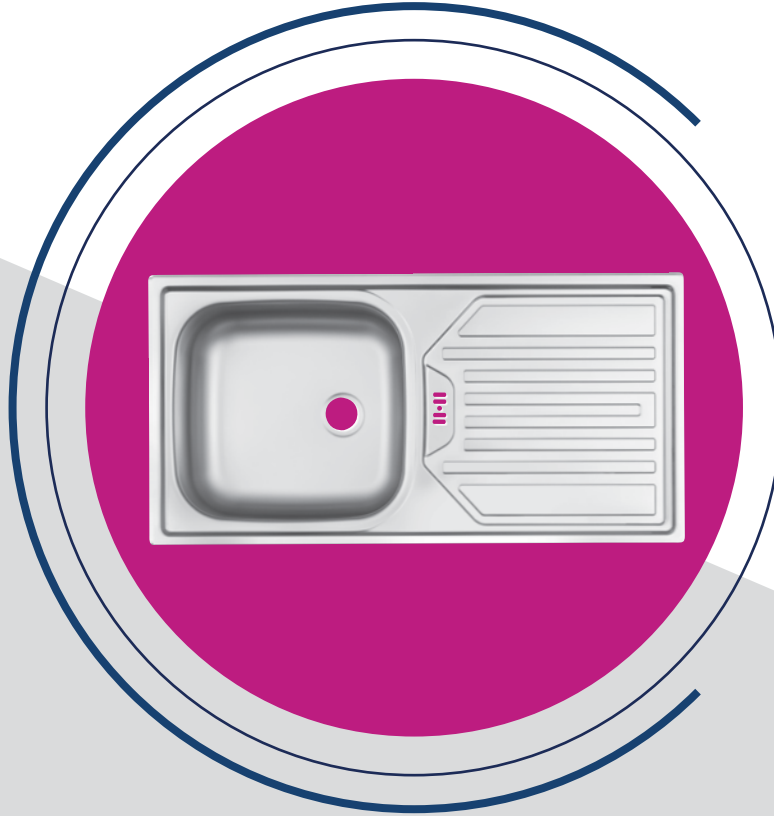

NRS 123S / Satin NRS 123L / Linen Inset

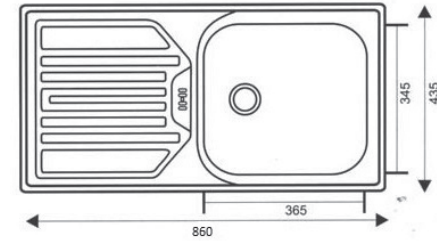

TEZGAH ALTI EVYE UNDERMOUNT SINK

ÖZELLİKLER / SPECIFICATION

Genel Ölçüler	Over All Dimensions	Ø 380 mm
Küvet Ölçüleri	Bowl Dimensions	380x180 mm
Kalınlık	Thickness	0.50 - 0.60 mm
Yüzey	Surface	Satin / Linen
Malzeme	Material	304 Paslanmaz Çelik / Stainless Steel
Sifon	Siphon	Büyük Sifon / Big Siphon Ø 90 mm (B) Küçük Sifon / Small Siphon Ø 55 mm (S)

NRS 125S / Satin

NRS 125L / Linen

Undermount

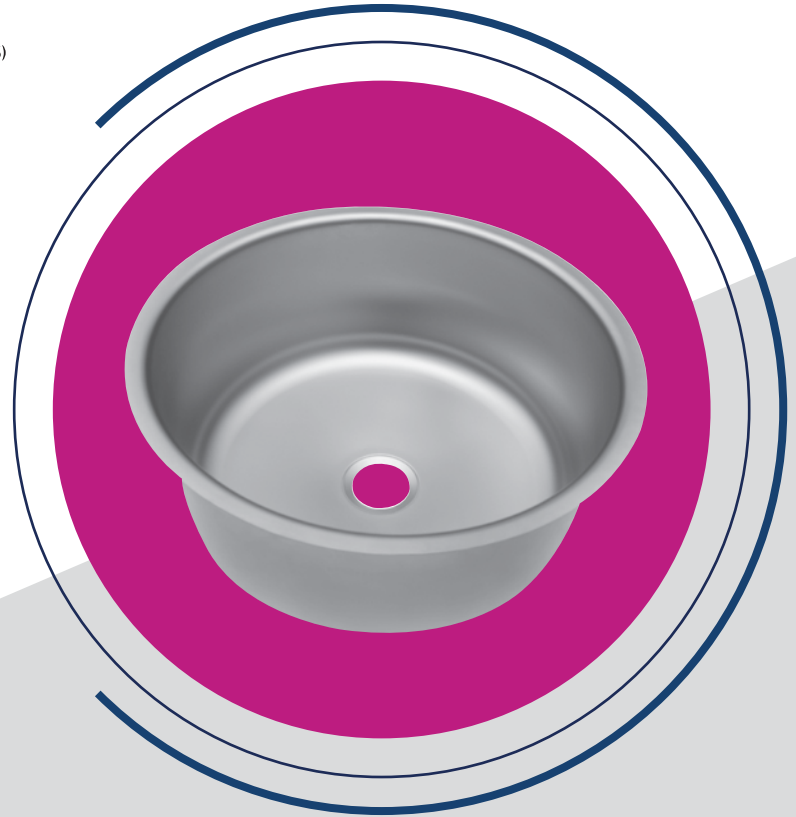
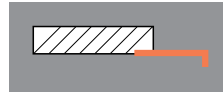

KOD/CODE
NRS- 128

TEZGAH ALTI EVYE UNDERMOUNT SINK

ÖZELLİKLER / SPECIFICATION

Genel Ölçüler	Over All Dimensions	390x450 mm
Küvet Ölçüleri	Bowl Dimensions	350x400 mm
Kalınlık	Thickness	0.50 - 0.60 - 0.80 -1.00 mm (Satin) 0.60 - 0.80 mm (Linen)
Yüzey	Surface	Satin / Linen
Malzeme	Material	304 Paslanmaz Çelik / Stainless Steel
Sifon	Siphon	Büyük Sifon / Big Siphon Ø 90 mm (B) Küçük Sifon / Small Siphon Ø 55 mm (S)

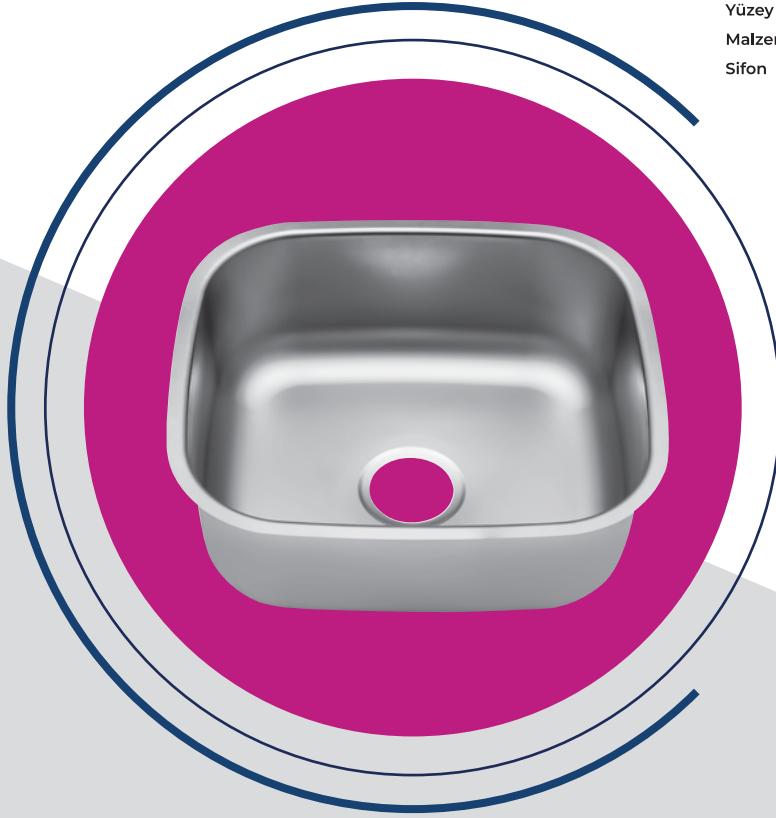

NRS 128S / Satin



NRS 128L / Linen



Undermount

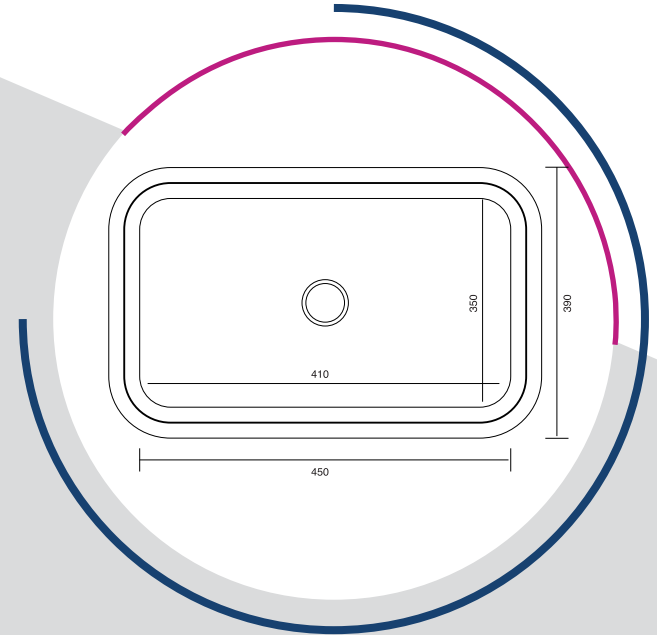
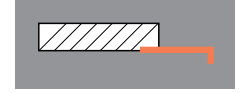

NORMO

TEZGAH ALTI EVYE UNDERMOUNT SINK

ÖZELLİKLER / SPECIFICATION

Genel Ölçüler	Over All Dimensions	420x520 mm
Küvet Ölçüleri	Bowl Dimensions	380x480 mm
Kalınlık	Thickness	0.50 - 0.60 - 0.80 -1.00 mm (Satin) - 0.60 - 0.80 mm (Linen) Satin / Linen
Yüzey	Surface	304 Paslanmaz Çelik / Stainless Steel
Malzeme	Material	Büyük Sifon / Big Siphon Ø 90 mm (B) Küçük Sifon / Small Siphon Ø 55 mm (S)

NRS 134S / Satin

NRS 134L / Linen

Undermount

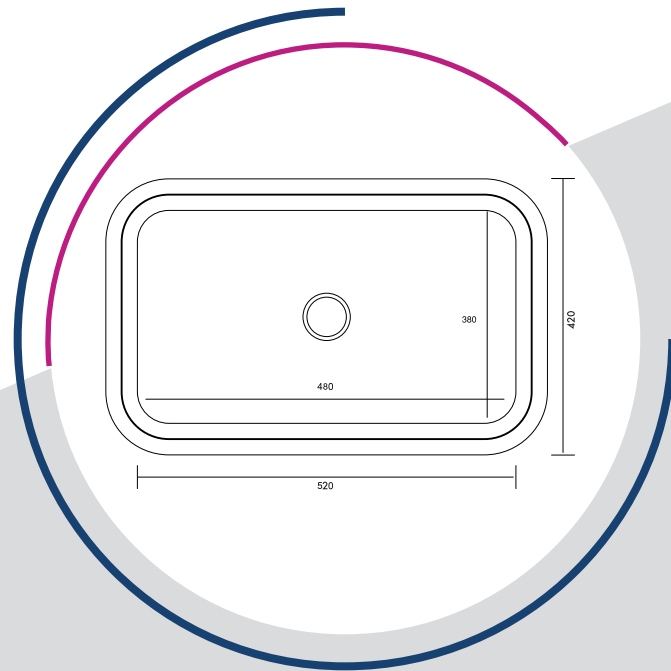
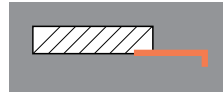

KOD/CODE
NRS- 140

TEZGAH ALTI EVYE UNDERMOUNT SINK

ÖZELLİKLER / SPECIFICATION

Genel Ölçüler	Over All Dimensions	440x490 mm
Küvet Ölçüleri	Bowl Dimensions	400x450 mm
Kalınlık	Thickness	0.50 - 0.60 - 0.80 -1.00 mm (Satin)
		0.60 - 0.80 mm (Linen)
		Satin / Linen
Yüzey	Surface	304 Paslanmaz Çelik / Stainless Steel
Malzeme	Material	Büyük Sifon / Big Siphon Ø 90 mm (B)
Sifon	Siphon	Küçük Sifon / Small Siphon Ø 55 mm (S)

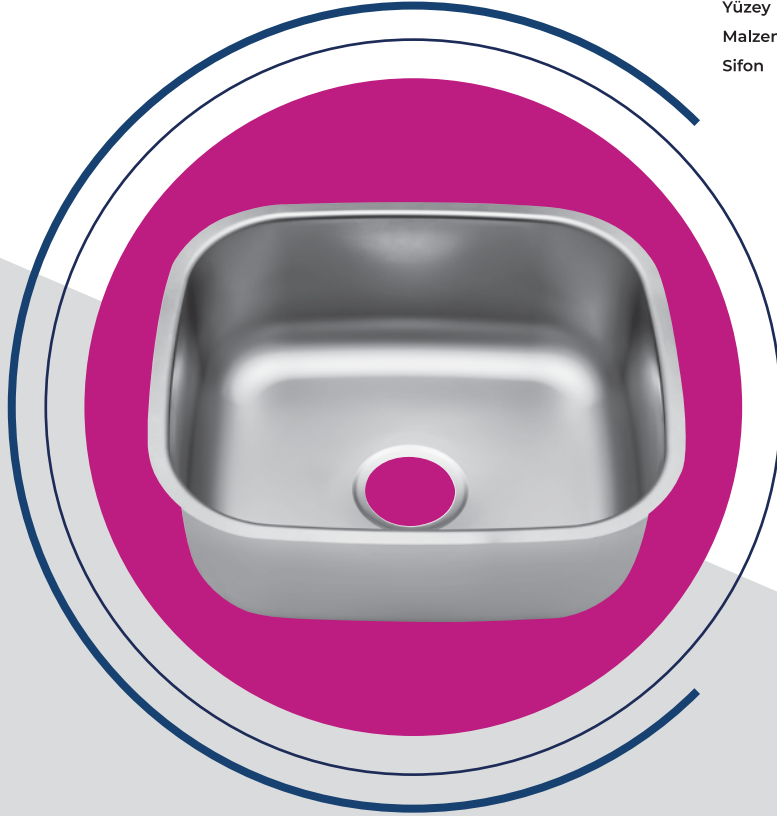

NRS 140S / Satin



NRS 140L / Linen



Undermount

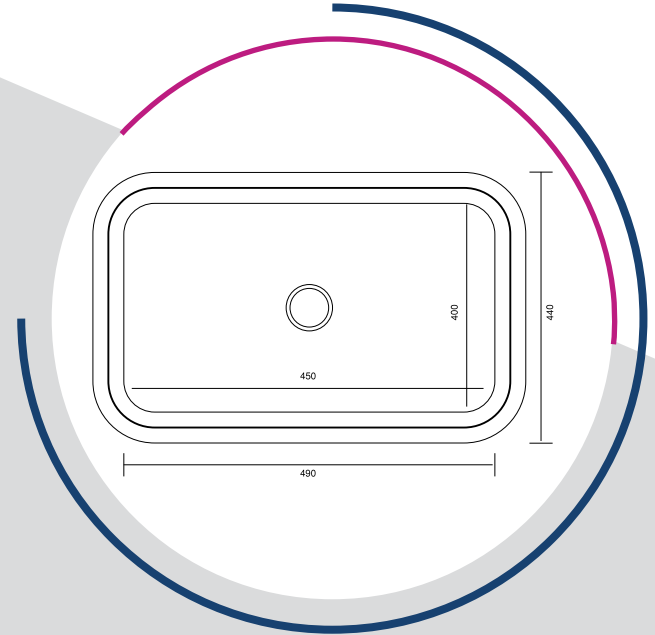
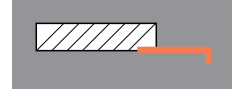

NORMO

ANKASTRE EVYE INSET SINK

ÖZELLİKLER / SPECIFICATION

Genel Ölçüler	Over All Dimensions	400x500 mm
Küvet Ölçüleri	Bowl Dimensions	336x395 mm
Kalınlık	Thickness	0.50 - 0.60 mm (Satin) 0.60 mm (Linen)
Yüzey	Surface	Satin / Linen
Malzeme	Material	304 Paslanmaz Çelik / Stainless Steel
Sifon	Siphon	Büyük Sifon / Big Siphon Ø 90 mm (B) Küçük Sifon / Small Siphon Ø 55 mm (S)
Damlalık Yönü	Dropper Direction	Sağ Damlalıklı / Right Dropper (R) Sol Damlalıklı / Left Dropper (L)
Taşma	Overflow	Taşma Açılacak / Overflow (W) Taşmasız / Without Overflow (X)
Musluk Deliği	Faucet Hole	Musluk Deliği Açılacak / Faucet Hole (F) Musluksuz / No Faucet Hole (X)
Düz Kenar	Flat Side	0.80 mm' de Düz Kenar Üretilbilir Flat Side are Manufactured at 0.80 mm

NRS 145S / Satin NRS 145L / Linen Inset

