

KOD/CODE

NRB-653-180

1800x450X450 / 900 mm

DOKTOR EL YIKAMA - YALAK TİP / DOCTOR HAND WASH

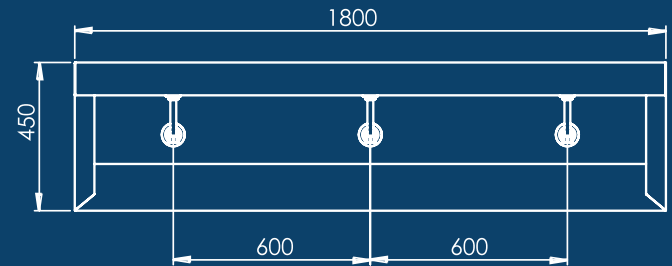
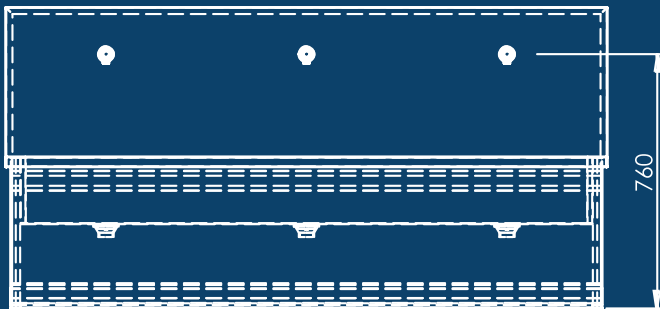
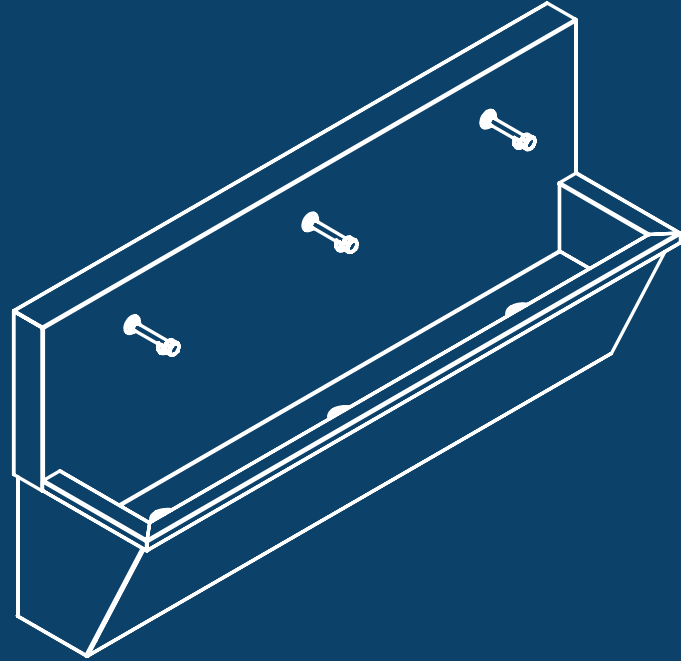

NORMO